

TOPAZ

Mobile DR System

*Wider Coverage
& Better Workflow*



Mobile DR System

Optimized Image Quality

It begins with Advanced Technology

Integrating high technology and over a decade of experience in conventional and digital radiography systems, DRGEM's TOPAZ is a state-of-the-art mobile digital radiography system, designed with maximum comfort for patients and users in mind. From its user-friendly software to smooth movements, TOPAZ is made to improve your workflow and provide you with high-quality images.

Options

- DAP(Dose Area Product) Meter
- Easily Detachable High Resolution Grid and Holder

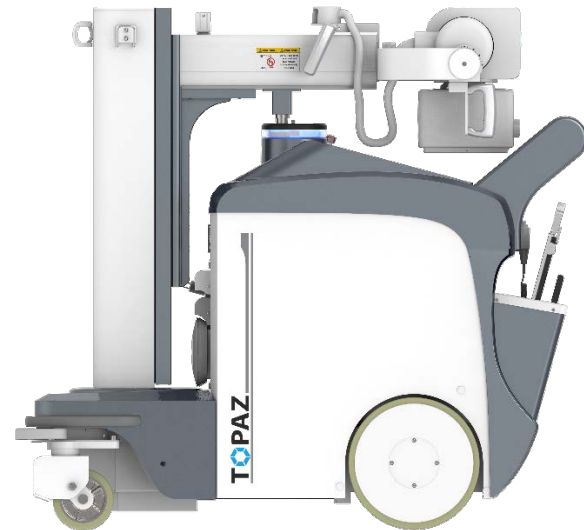

Full Featured Imaging Software & Excellent Digital Image Processing

With a high-performance, built-in touchscreen, TOPAZ offers a user-friendly interface and powerful software for easy operation and increased workflow. The anatomical view-based digital image processing automatically optimizes and enhances the quality of the image, with automatic image storage and print with DICOM 3.0 networking capability, increasing exam throughput and decreasing examination time.

- Provides convenient user interface and easy operation
- Anatomical view-based digital image processing
- Radiographic stand and automatic collimator control function
- DICOM 3.0 networking interface features include: worklist, print, store, and query for integration with any PACS or RIS

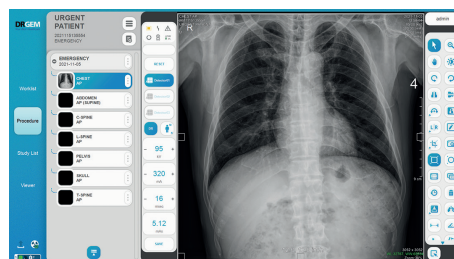

Wider Coverage

Longer arm stroke and high column provide wider coverage and patient-friendly operation service

Safety Function

Front safety bumper & brake, spring loaded front wheel, and status LED indicator provide safety and convenience for your patient and operator. It will prevent any unexpected / secondary accident.

Accurate Positioning & Movement

Accurate positioning and precise movement provided with 4 direction buttons on this control panel



Optimized Image Quality

Outstanding image quality by optimized digital image processing

Ergonomic and Compact Design

Easy driving and maneuverability with ergonomic and compact design

Convenient Storage Compartment

Enough space for detector, battery and other necessary equipment

Swift Mobility

5km/h speed allows you to save time and cost, satisfying your patients with quick processing

Remote Controller

Easy and convenient control of X-ray exposure and collimator lamp



Specification

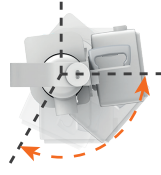

Tube axis: -30 ~ +90°

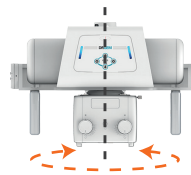

Collimator Rotation: ±120°

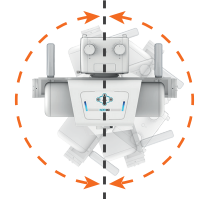

Transverse arm axis: ±180°

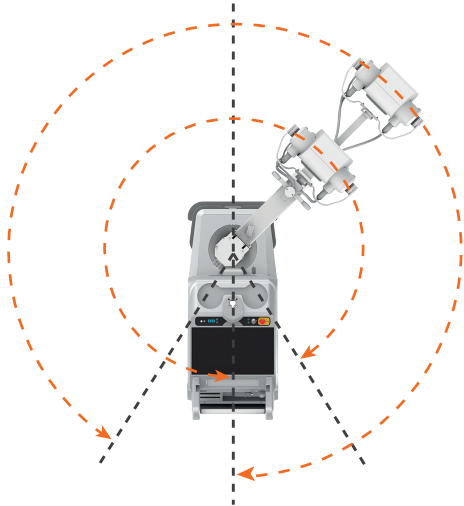

Column Rotation : ±330°

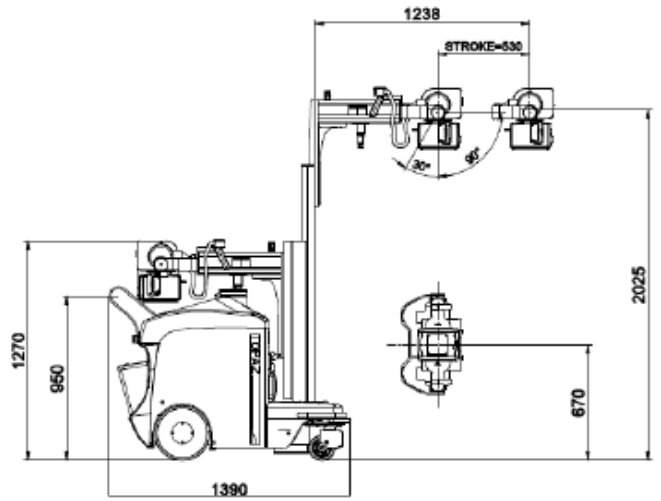
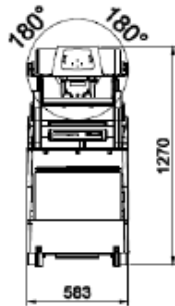

X-ray System

Model	TOPAZ-32D	TOPAZ-40D
Output Rating	32kW	40kW
kV Range	40~125kV / 150kV	
mA Range	10 to 400mA	10 to 500mA
mAs Range	0.1 to 500mAs	

Digital Flat-panel Detector

Size	14x17inch	17x17inch
Scintillator	CsI / GOS	
Type	Wireless	

DRGEM Customer Service Center

● 24/7 Support

DRGEM's Customer Service team is available 24/7, 365 days a year* via e-mail or Skype to support clients whenever they need.

● Remote Diagnosis

Remote diagnosis can help minimize downtime by quickly finding the cause of errors and detecting potential issues before problems occur.

*May vary by country.

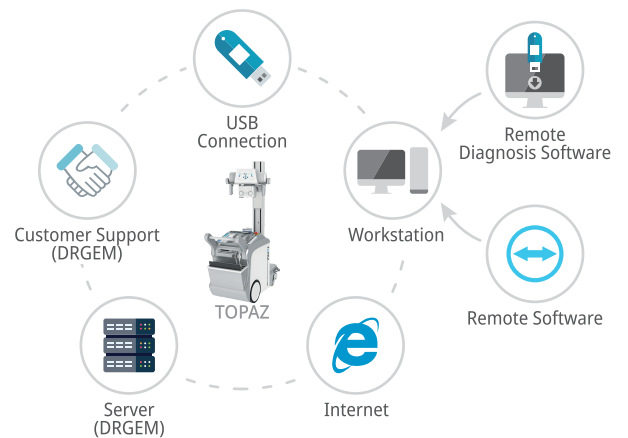

© DRGEM Corporation - All rights reserved. Reproduction in whole or in part is prohibited without the written consent of the copyright-holder. Specifications and features are subject to change without notice. All changes will be in compliance with regulations governing manufacture of medical equipment.